



# Linear

yhteensopiva Mix&Match sarjan kanssa

[www.marlea.fi](http://www.marlea.fi)

# MARLEA



# Linear

**Linear** ratkaisuja on saatavilla monissa kokoonpanoissa, mukaan lukien: toteemipylväät, kolme yhdeksän metriä leveisiin kuvaseiniin, pylväisiin ja kaareihin; ja ne voidaan myös tehdä mittojen mukaan.

**Rakenne:** Mainosseinä seisoo omalla jalustallaan

**Kokoaminen:** Kokoamiseen ei tarvita työkaluja

**Telineen rakenne:** Alumiiniputket, halkaisija 30mm

**Mainoskangas:** 260 g/m<sup>2</sup> stretch-kangas mukautuu täydellisesti rakenteeseen

**Kankaan tulostus:** Yksi- tai kaksipuoleinen grafiikkatulostus

**Mainosgrafiikan tulostustarkkuus:** jopa 1440 dpi

**Mainoskankaan kiinnitys:** Tukeva ja napakka vetoketju

**Pestävyys:** Mainoskankaan voi konepestä toistuvasti, suosittelimme matalaa pesulämpötilaa ja kirjopesuainetta.

**Paloluokitus:** B1 paloluokitus stretch-kankaalle





# Linear

Telineen rakenne:

Alumiiniputkien halkaisija 30 tai 50 mm

260 g/m<sup>2</sup> stretch-kangas mukautuu täydellisesti rakenteeseen.  
Grafiikakankaan kiinnitys tukeva ja napakka vetoketju.  
Kankaalla on B1 paloluokitus.

Työkalusarja, jossa laukku, puuvillakäsineet lisäksi  
4 kuusiokoloavainta on lisätty mittatilaustyö raken-  
teisiin.

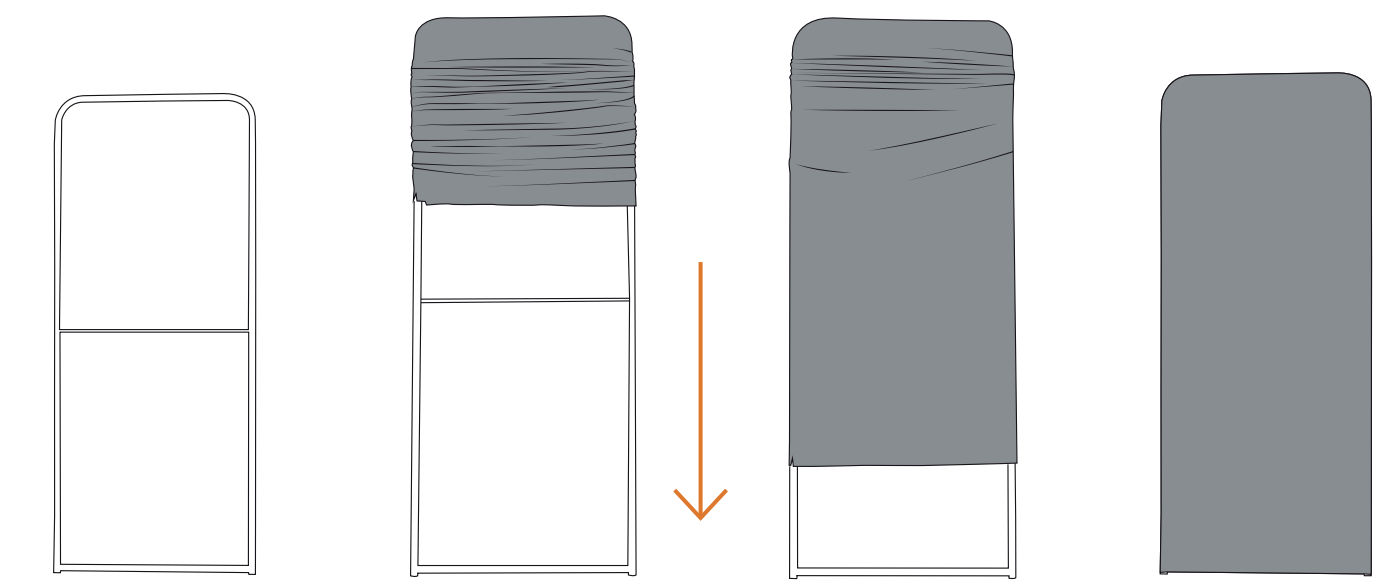

# Linear

Havainne kokoamisesta.

Kokoaminen on helppo ja nopeaa, alumiin-putket ovat numeroituja ja osa osista kiinnittoisissaan joustonarulla.

Kangas pukotetaan rakenteeseen yläkautta. Mukana on myös hanskat, jotta et likaa kangasta. Lopuksi alhaalta vetoketju

Viimeistele jalkojen asennuksella, jalaksien pohjassa on havainne tarra, joka kertoo mihin suuntaan käännät lukituksen / avaamisen

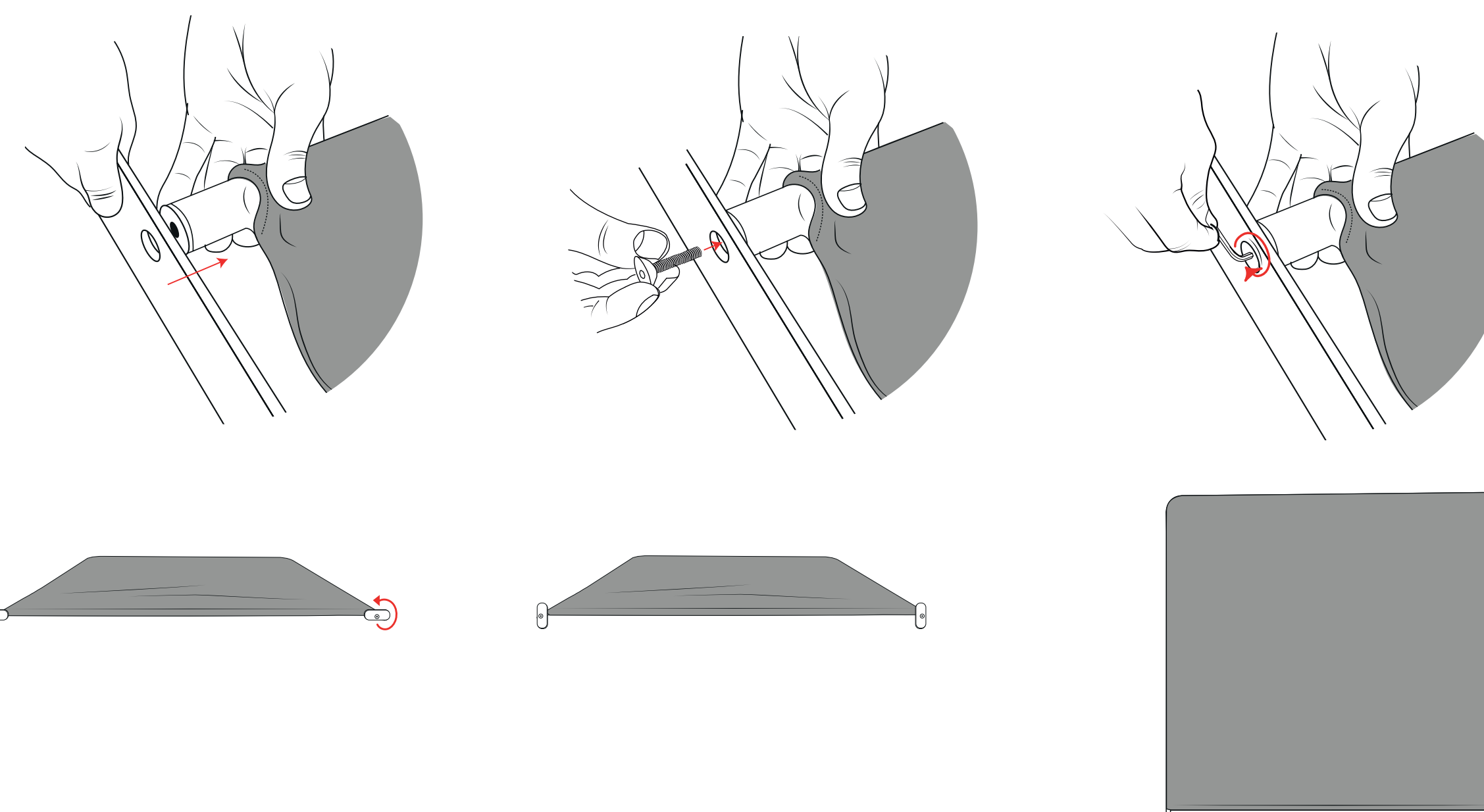
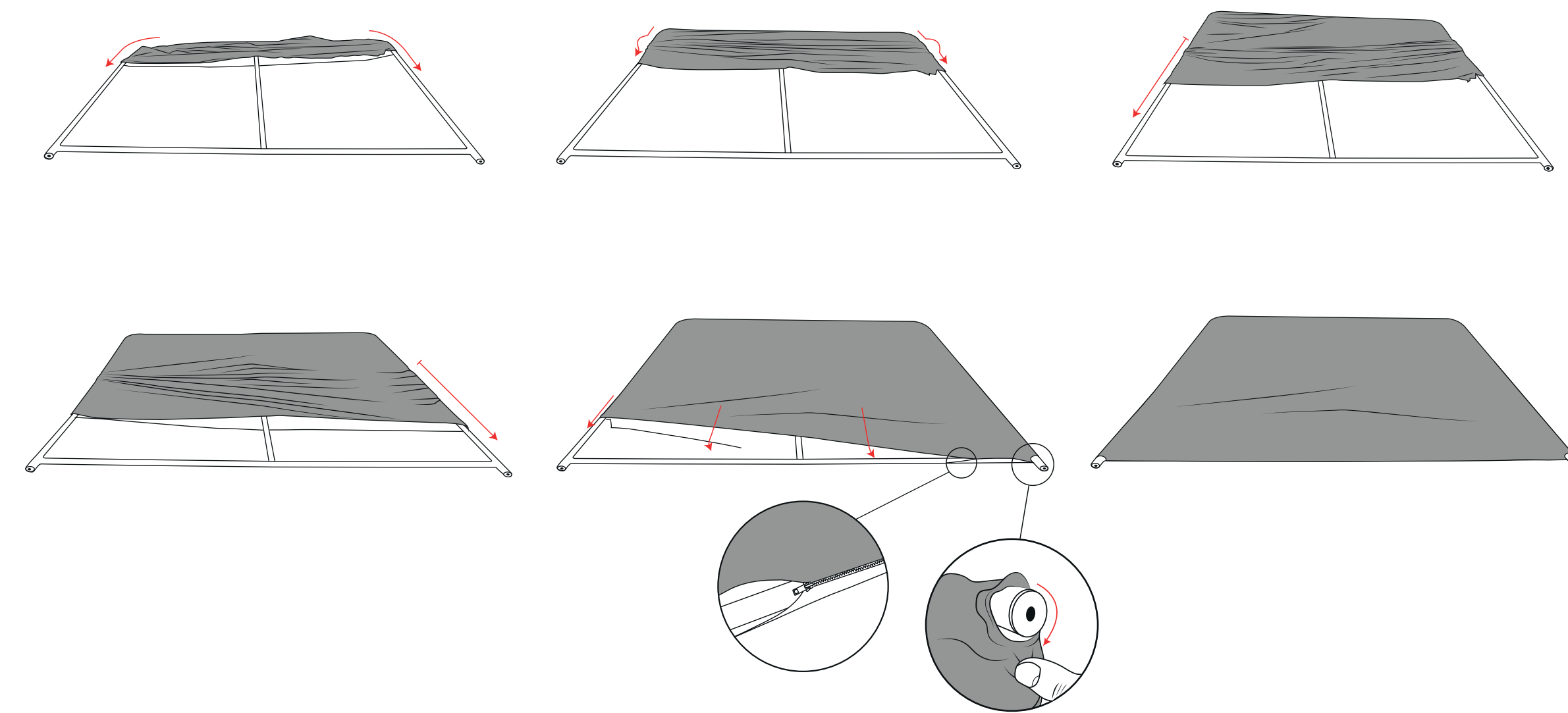
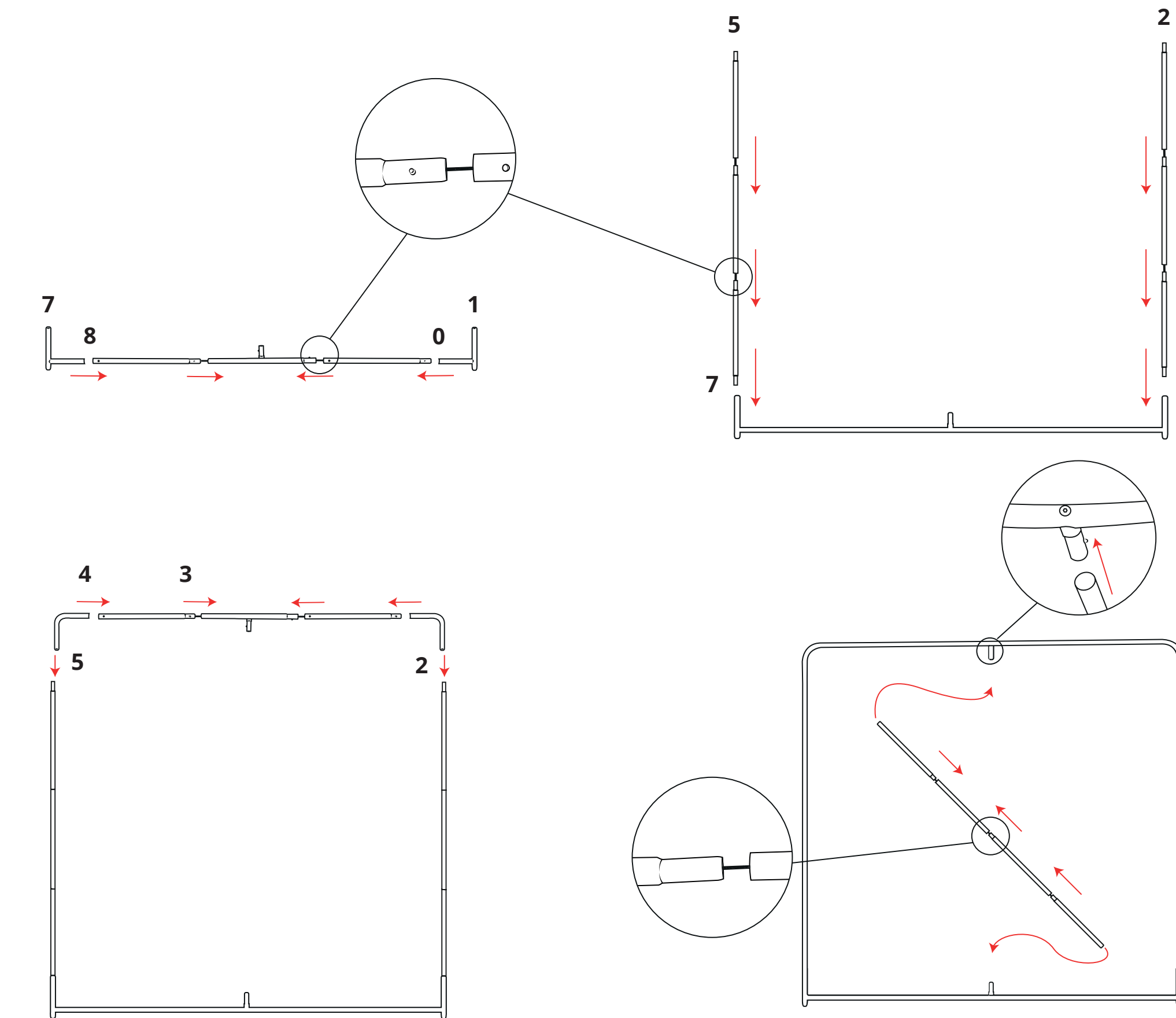



# Linear

Kokoaminen ei vaadi työkaluja. Jokainen osa on merkitty numeroilla ja värikoodauksella helpottamaan kokoamista, liittäminen painonapilla.



Kun rakenne on koottu, Twist & Lock -jalat lukitaan paikalleen kiertämällä ne runkoon. Jalaksen pohjassa on tarra näytäämässä kiertosuuntaa.

Saatavana valinnainen puolijalusta käytettäväksi seinää vasten.

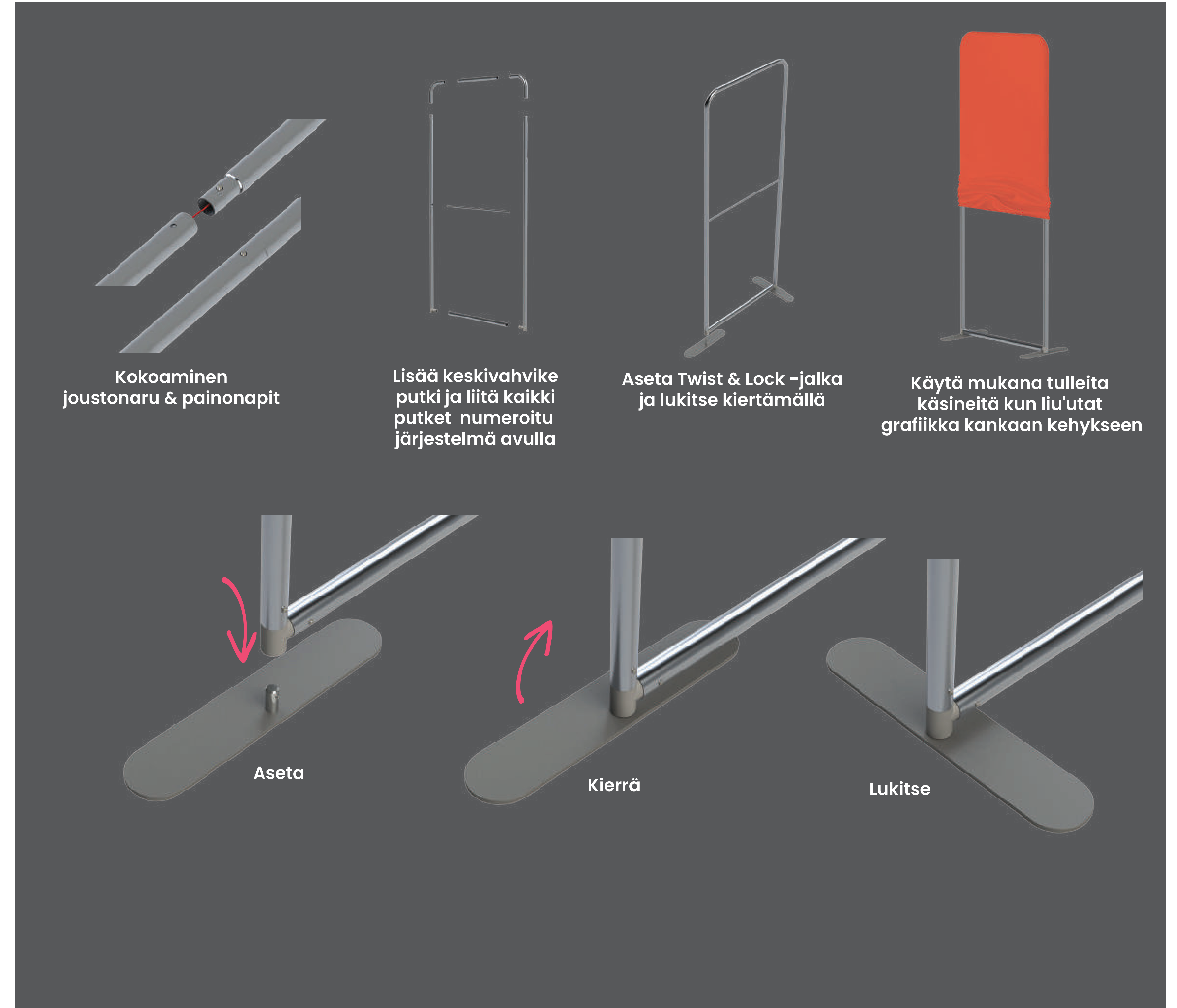



# Linear

Messuseinä suora

2400 mm  2380 (k) x 2350 (l) x 400 (s) mm

3000 mm  2380 (k) x 2950 (l) x 400 (s) mm

4000 mm  2380 (k) x 3950 (l) x 400 (s) mm

5000 mm  2380 (k) x 4950 (l) x 400 (s) mm

6000 mm  2380 (k) x 5950 (w) x 400 (s) mm

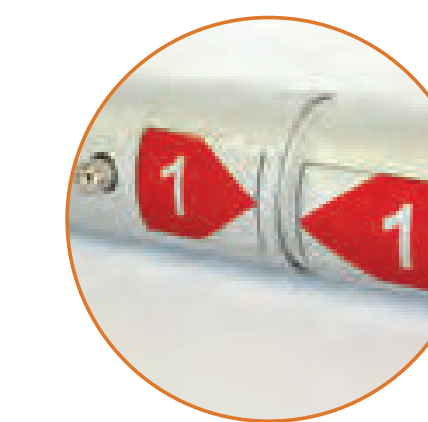
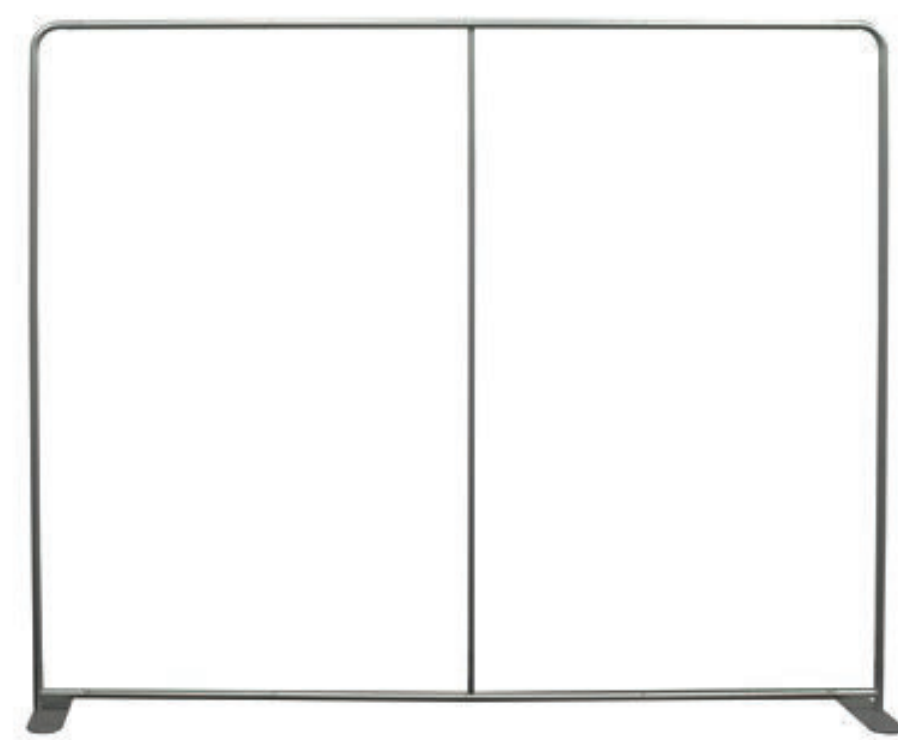



# Linear

Messuseinä kaareva vertikal

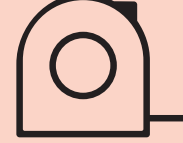
2400 mm  2380 (k) x 2350 (l) x 608 (s) mm

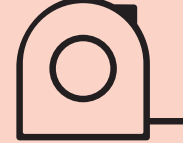
3000 mm  2380 (k) x 2950 (l) x 608 (s) mm

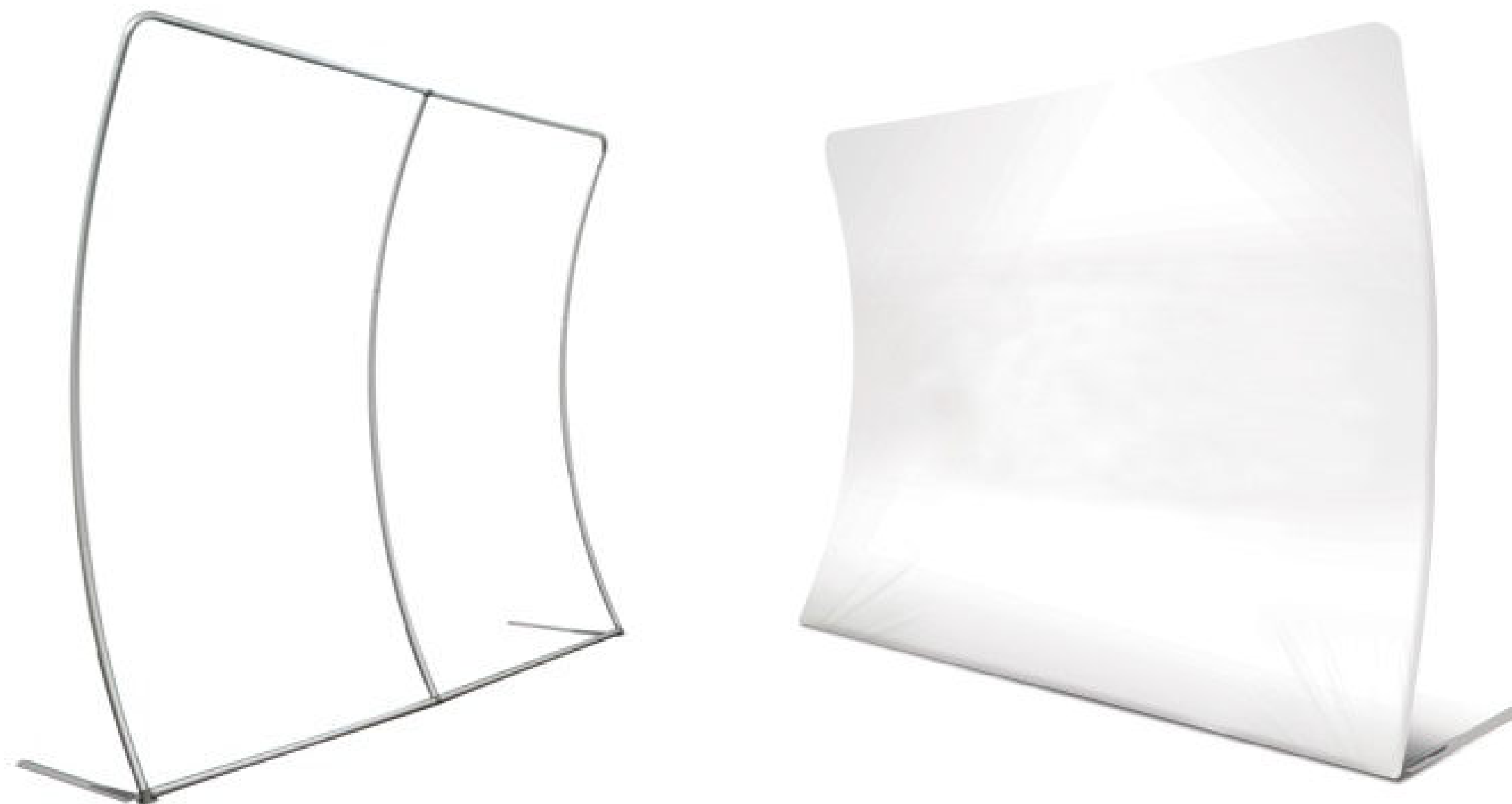

# Linear

## Messuseinä kaareva horisontal

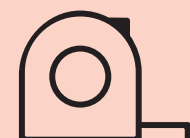
2400 mm  2380 (k) x 2350 (l) x 400 (s) mm

3000 mm  2380 (k) x 2958 (l) x 400 (s) mm

6000 mm  2380 (k) x 5950 (l) x 400 (s) mm

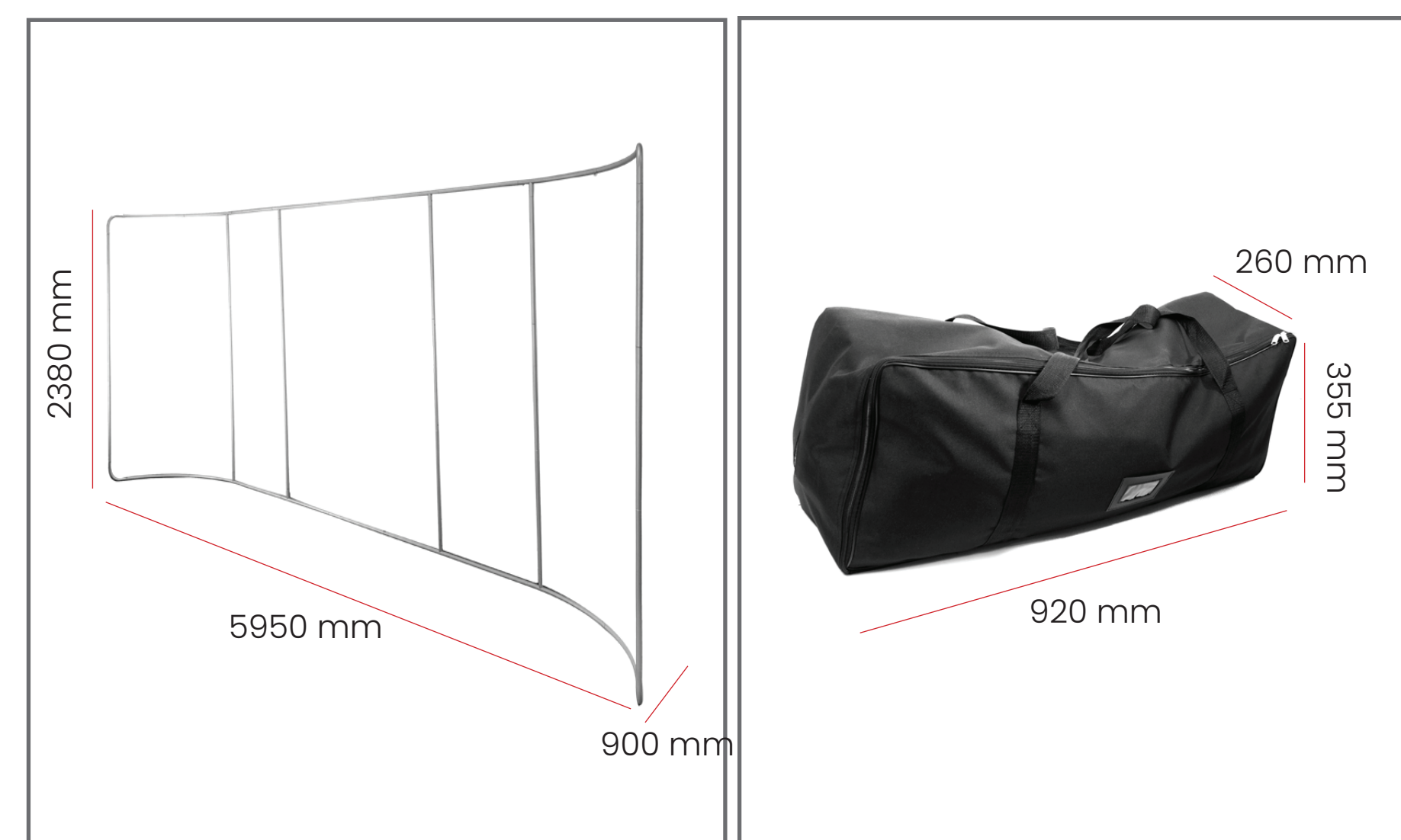
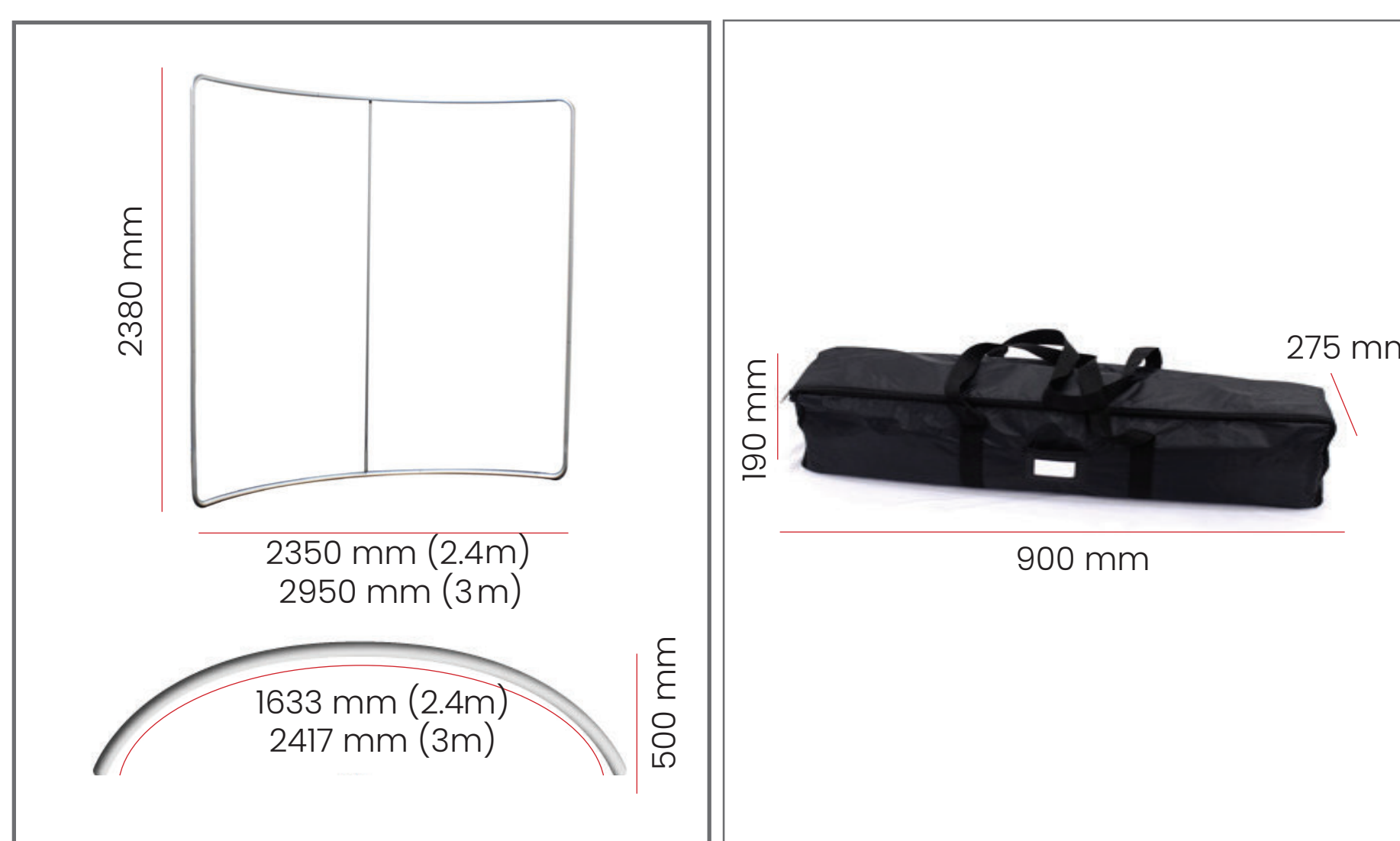

6 m





# Linear

## Messuseinä serpentiini

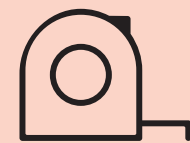
2400 mm  2380 (k) x 2350 (l) x 400 (s) mm

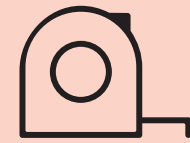
3000 mm  2380 (k) x 2950 (l) x 400 (s) mm

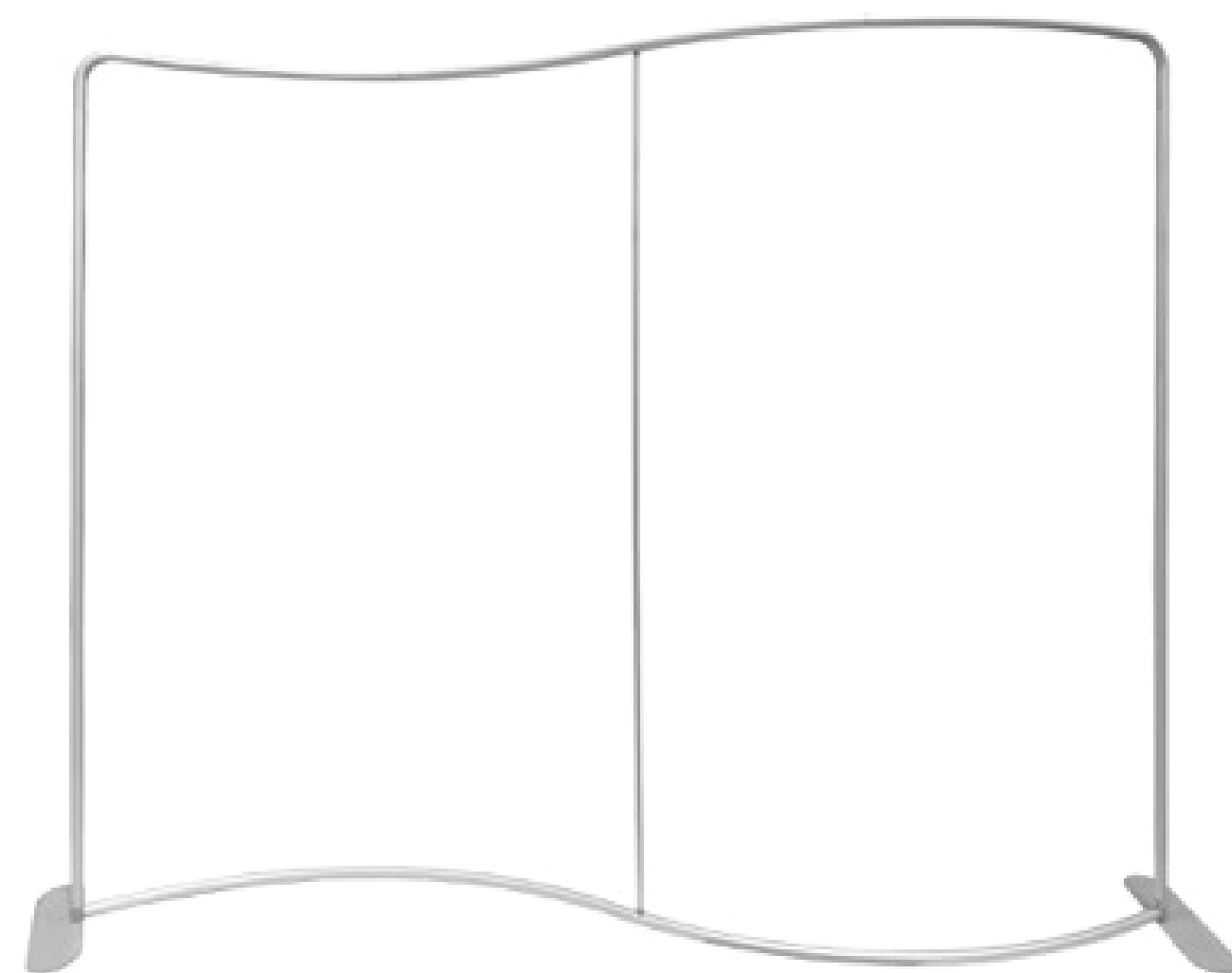

# Linear

## Messuseinä kaari

3000 mm  3000 (k) x 4000 (l) x 900 (s) mm

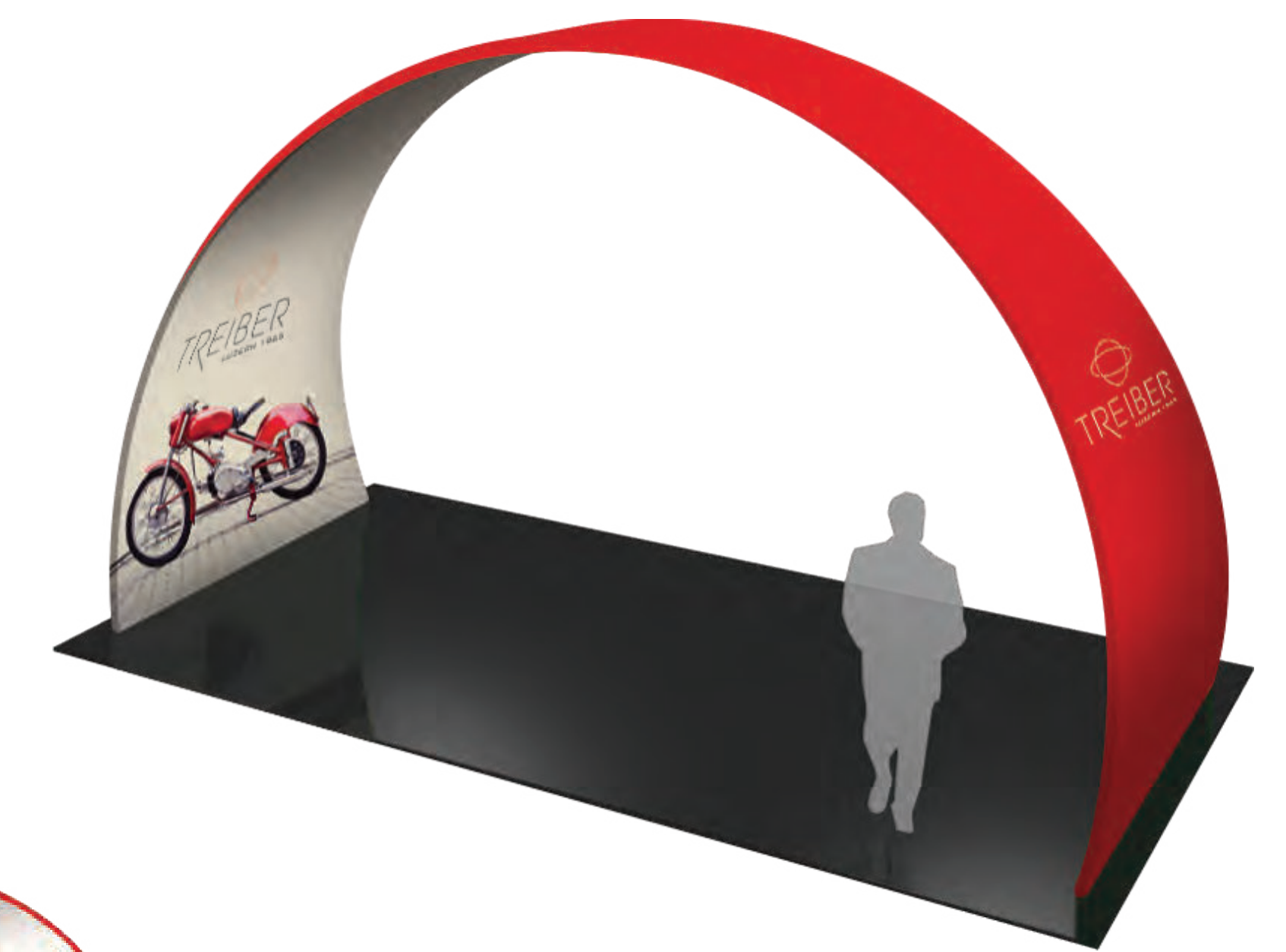
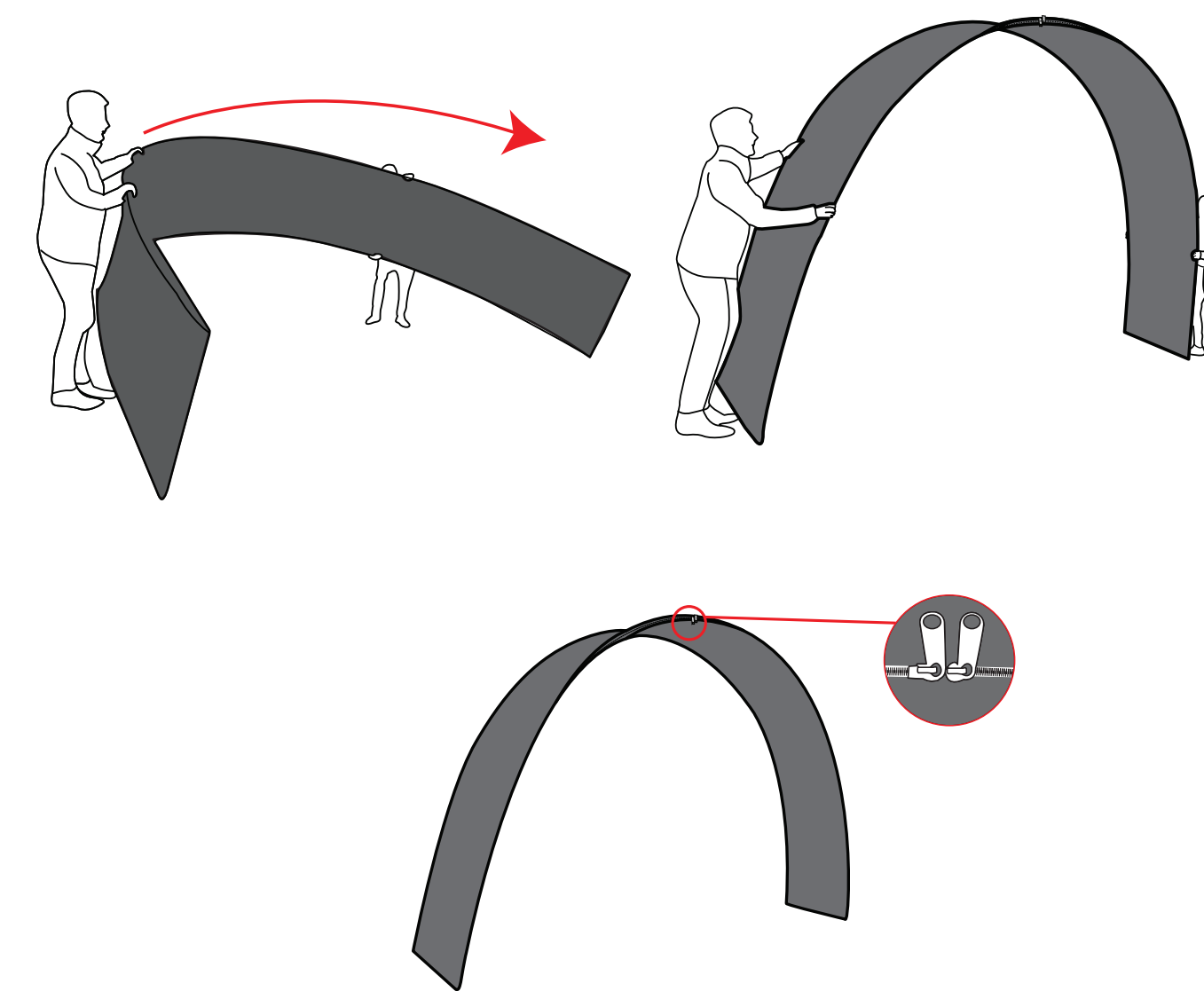
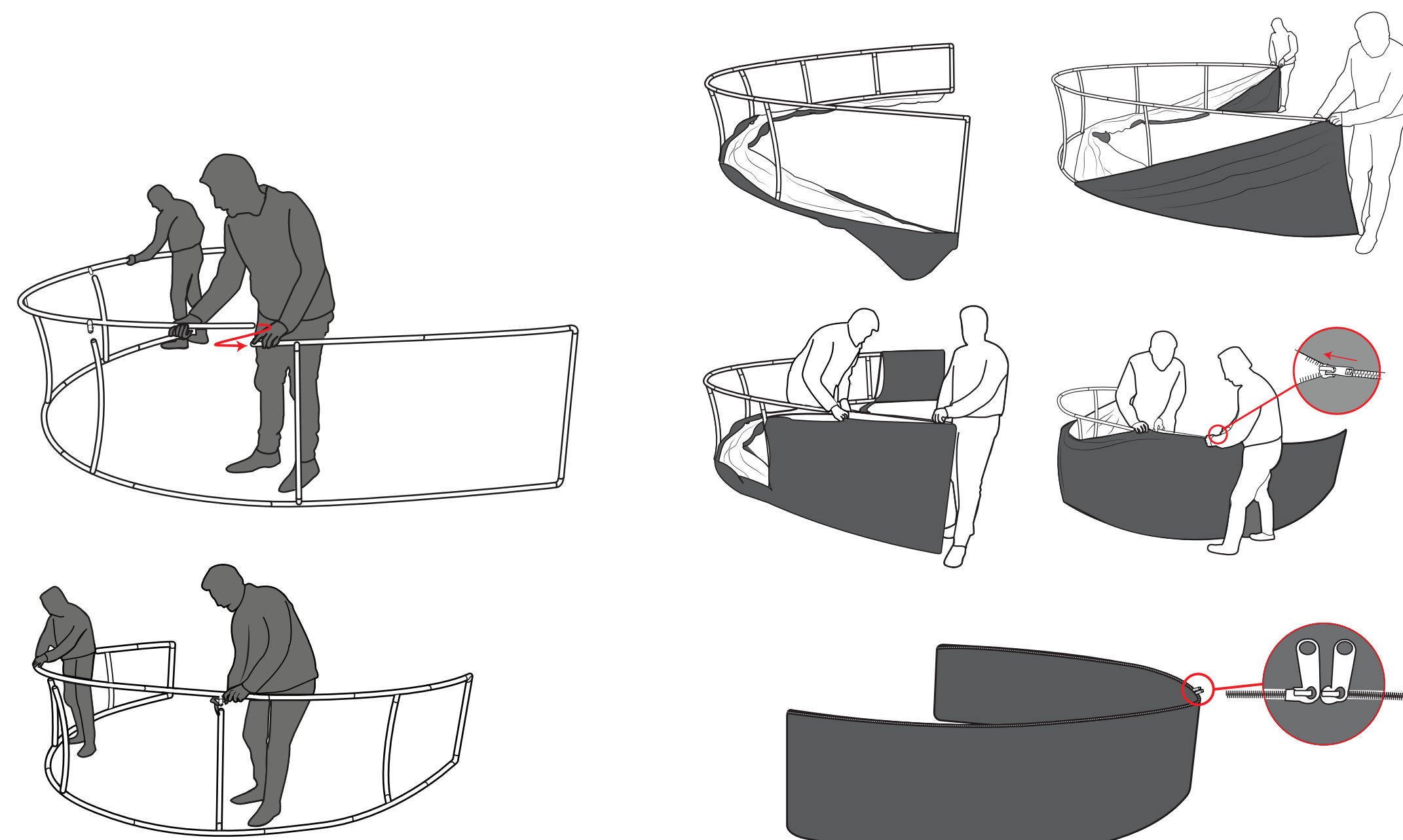
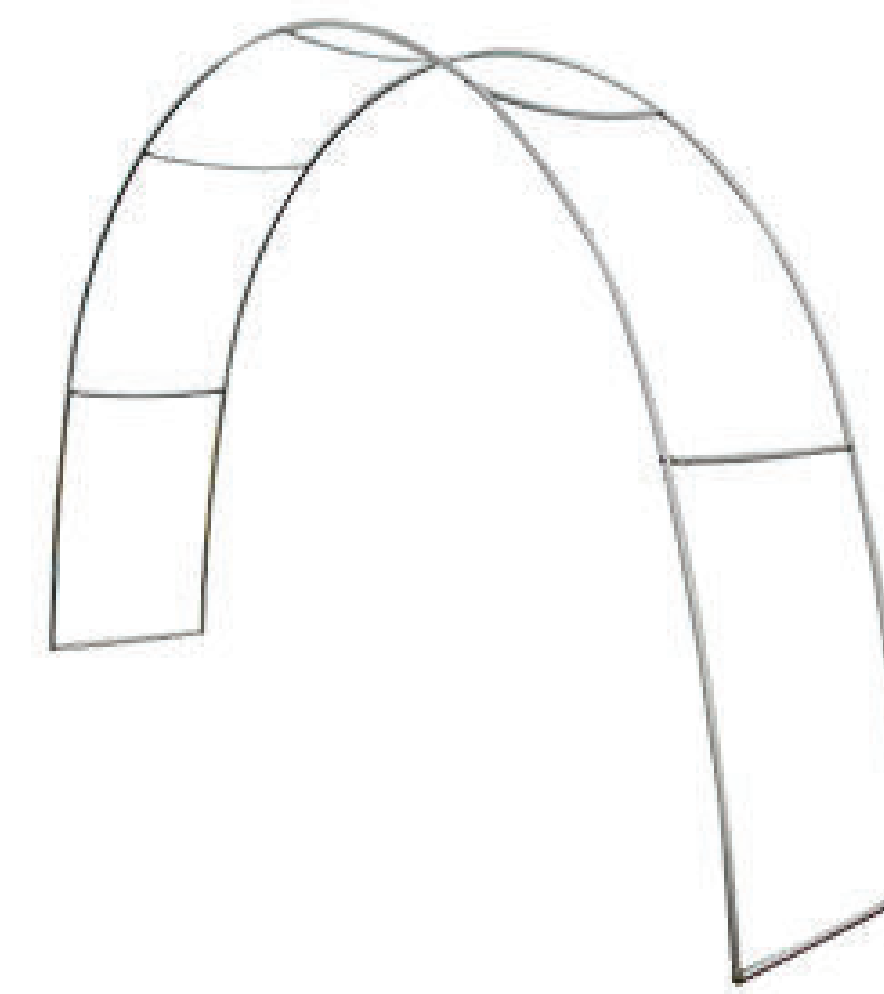

Custom made





# Linear

## Messuseinä Meeting Pod

📏 2100 (k) x 2900 (l) x 2550 (s) mm

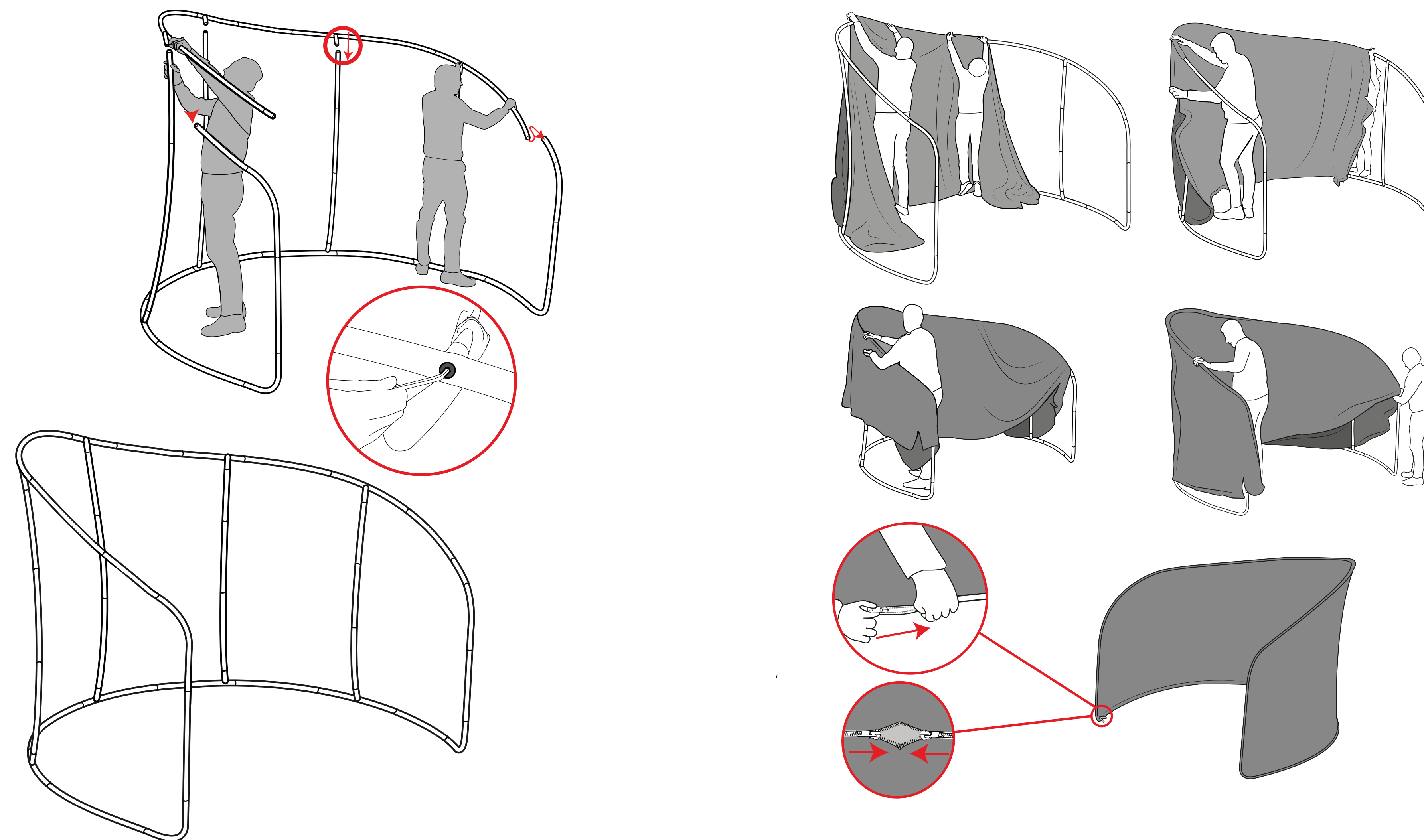

# Linear

## Messuseinä Chip

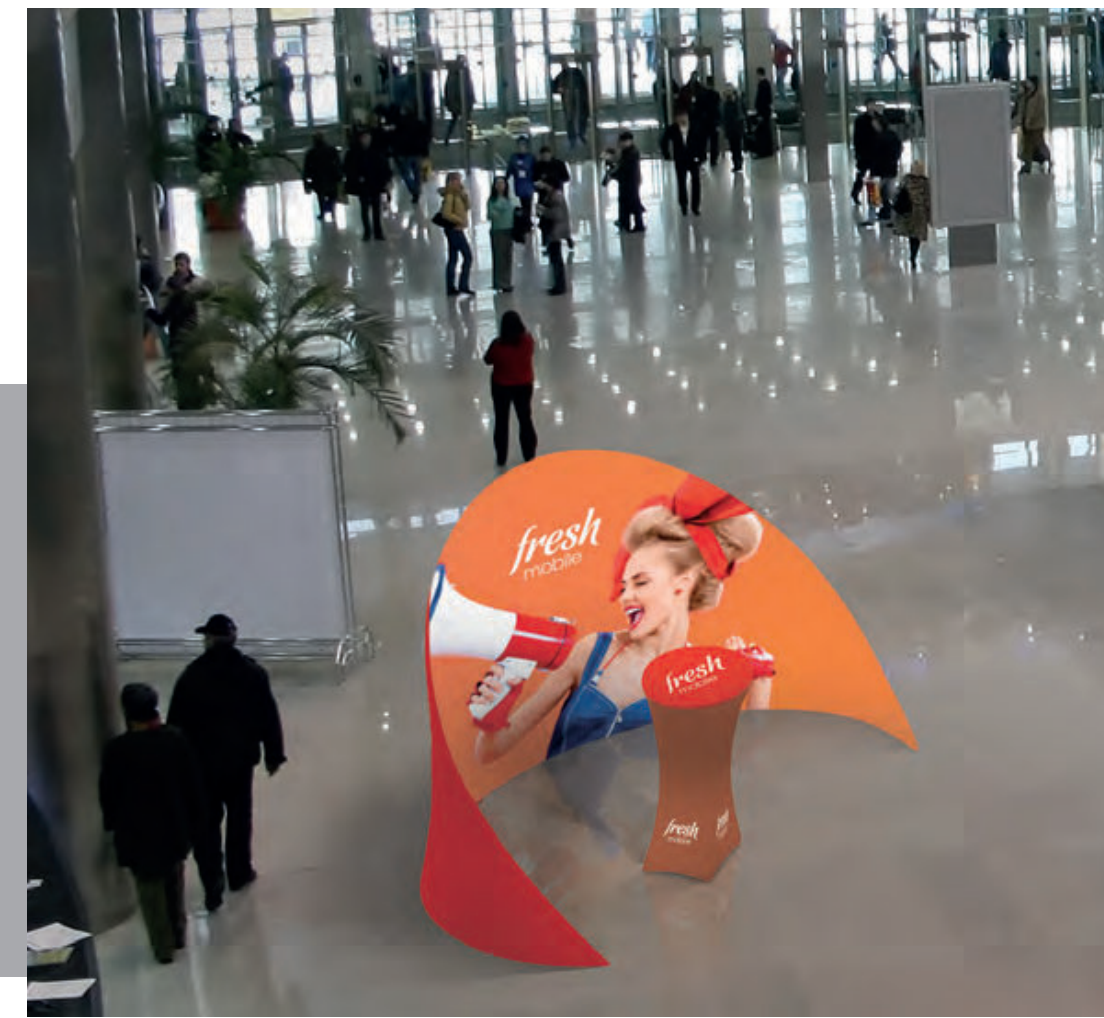

📐 1756 (k) x 3000 (l) x 1820 (s) mm



## Messuseinä Shape

📐 2000 (k) x 2550 (l) x 1614 (s) mm

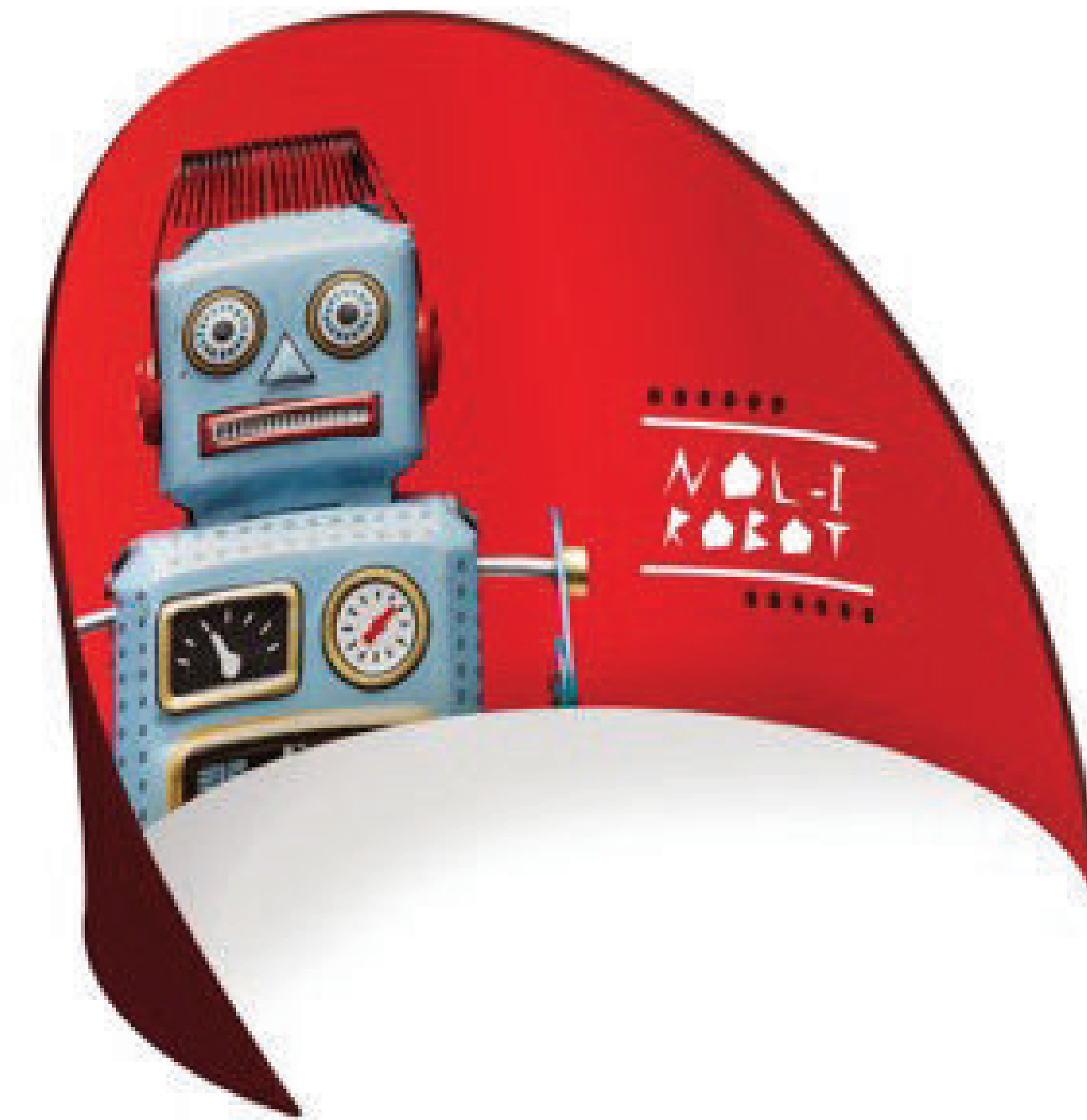
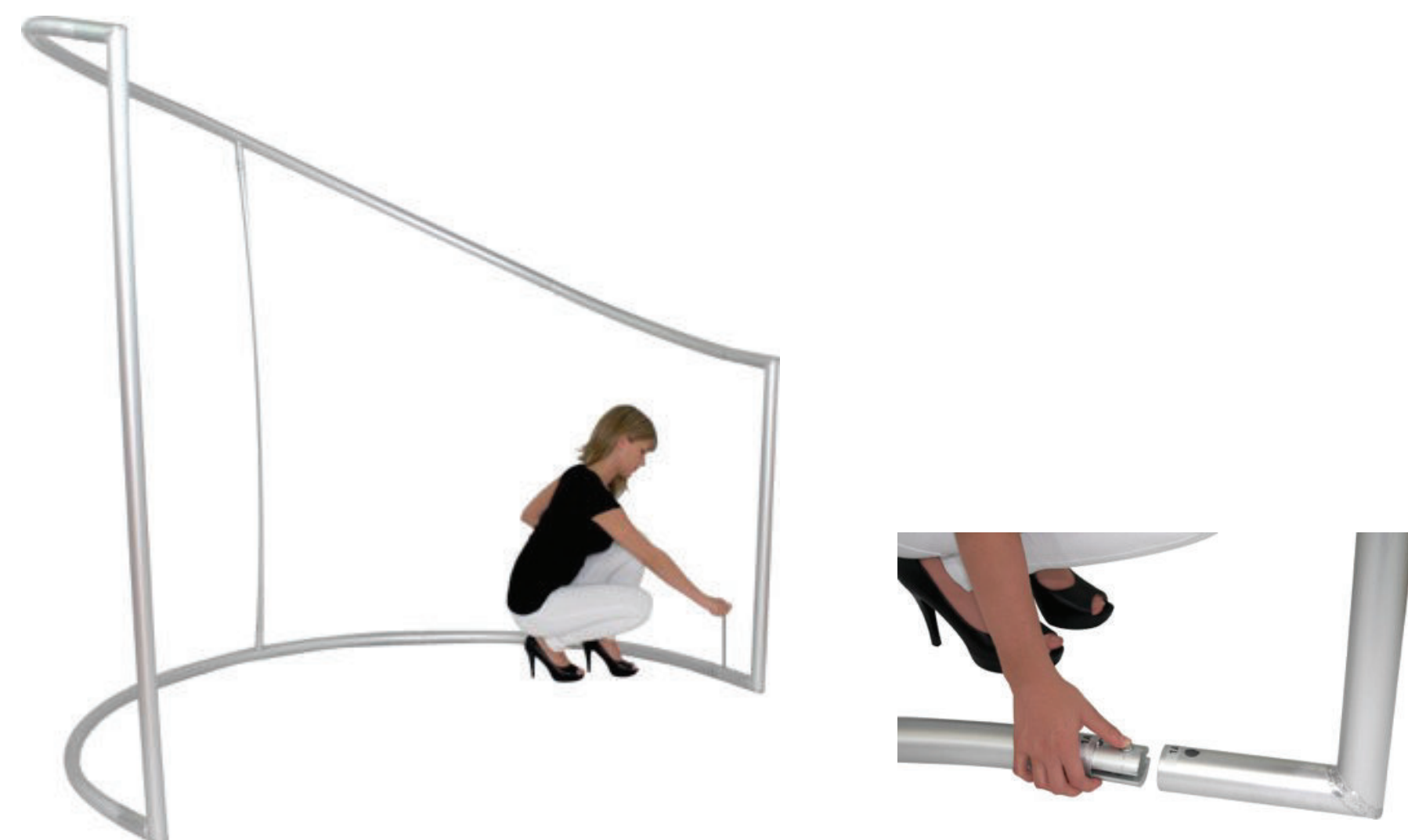











# Linear

## Katosta roikkuvat









Ovaali 250  1000 (k) x 2500 (l) x 940 (s) mm  
Ovaali 350  1000 (k) x 3500 (l) x 1329 (s) mm

Wheel 250  1000 (k) x 2500 (l) x 2500 (s) mm  
Wheel 350  1000 (k) x 3500 (l) x 2500 (s) mm



Ympyrä 150  750 (k) x 1500 (l) x 1500 (s) mm  
Ympyrä 250  1000 (k) x 2500 (l) x 2500 (s) mm  
Ympyrä 350  1000 (k) x 3500 (l) x 3500 (s) mm  
Ympyrä 500  1200 (k) x 5000 (l) x 5000 (s) mm







Aalto 350  1000 (k) x 3500 (l) x 30(s) mm  
Aalto 500  1000 (k) x 5000 (l) x 50 (s) mm

Neliö 150  750 (k) x 1500 (l) x 1500 (s) mm  
Neliö 250  1000 (k) x 2500 (l) x 2500 (s) mm  
Neliö 350  1000 (k) x 3500 (l) x 3500 (s) mm  
Neliö 500  1200 (k) x 5000 (l) x 5000 (s) mm

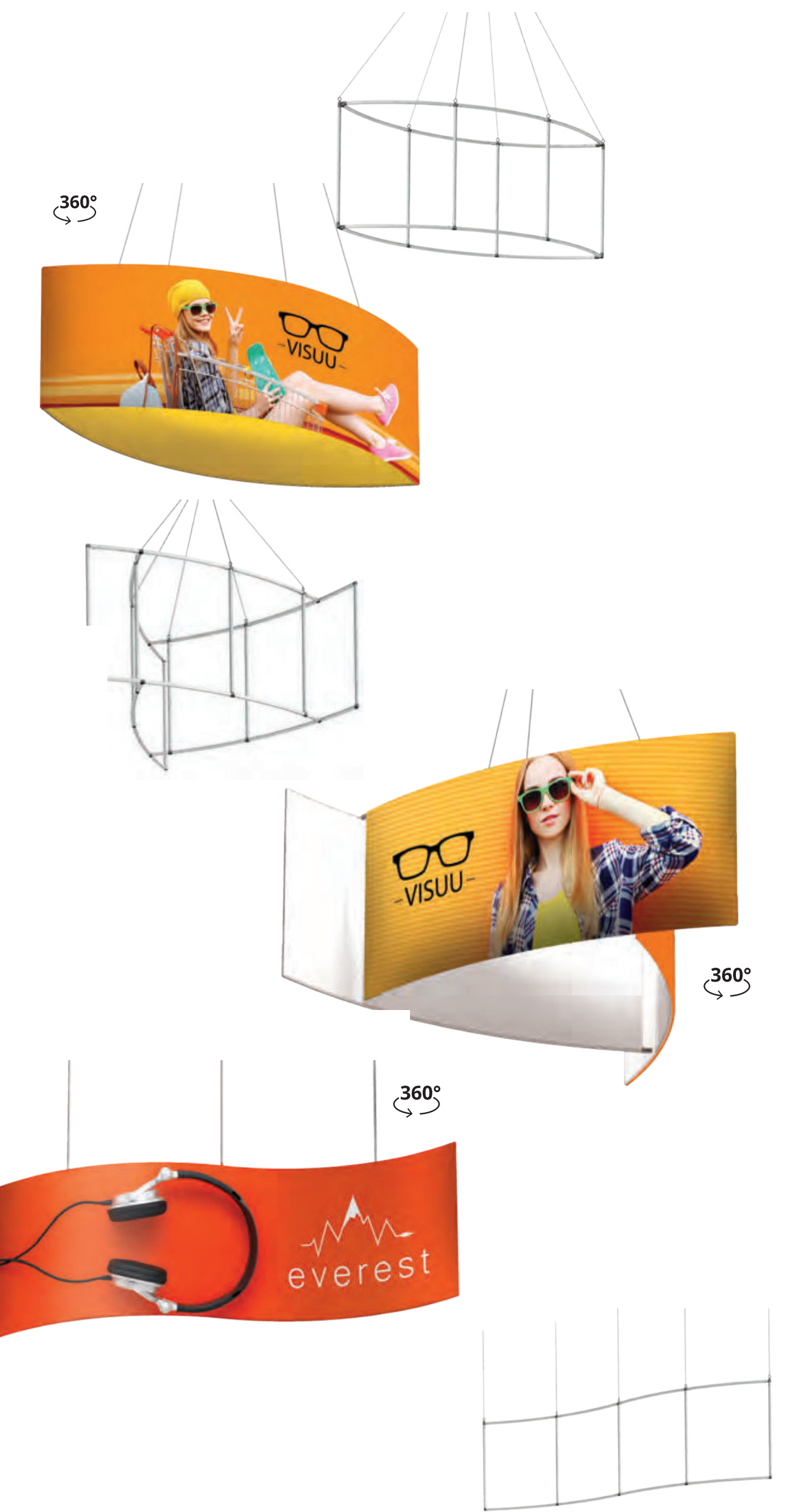



Paneli 250  100 (k) x 2500 (l) x 30 (s) mm  
Paneli 350  1000 (k) x 3500 (l) x 50 (s) mm  
Paneli 500  1200 (k) x 5000 (l) x 50 (s) mm



Pyöristetty 150  1000 (k) x 2500 (l) x 2500 (s) mm  
Pyöristetty 350  1000 (k) x 3500 (l) x 3500 (s) mm  
Pyöristetty 500  1200 (k) x 5000 (l) x 5000 (s) mm



Suorakulma 250  100 (k) x 2500 (l) x 1200 (s) mm  
Suorakulma 350  1000 (k) x 2500 (l) x 3500 (s) mm  
Suorakulma 500  1200 (k) x 2500 (l) x 5000 (s) mm

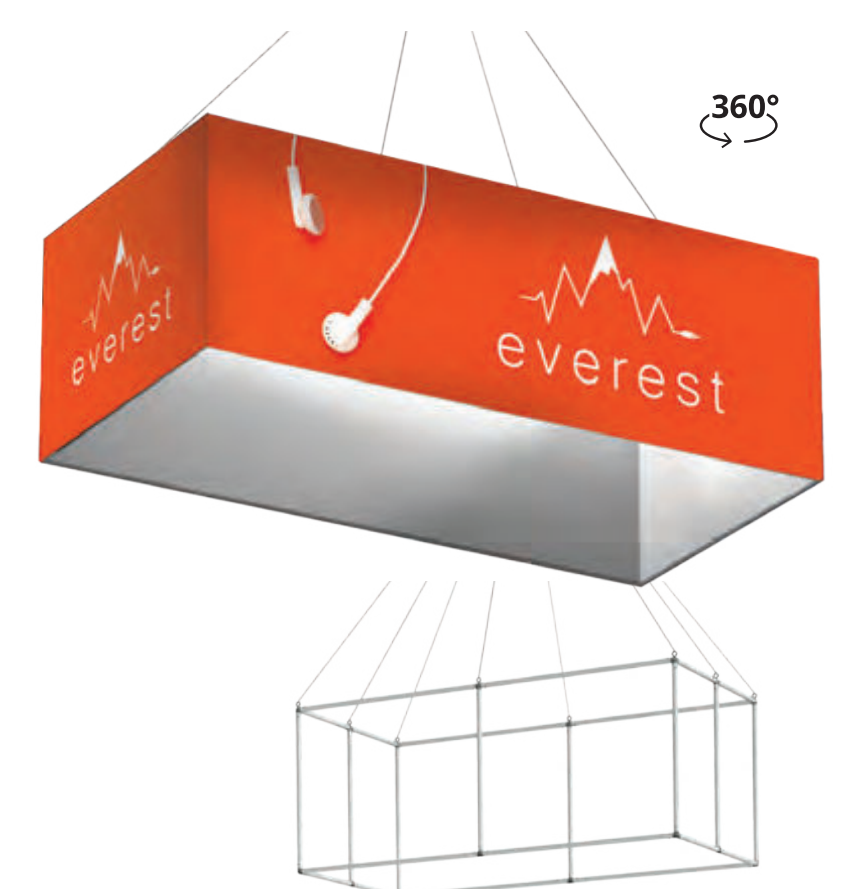



# Linear

Katosta roikkuvat Custom Made

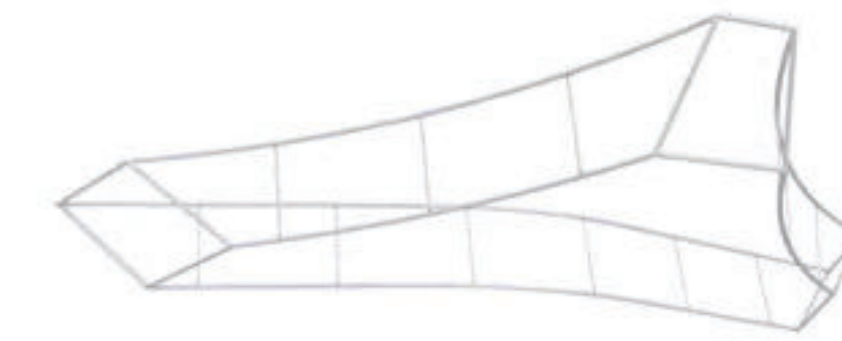
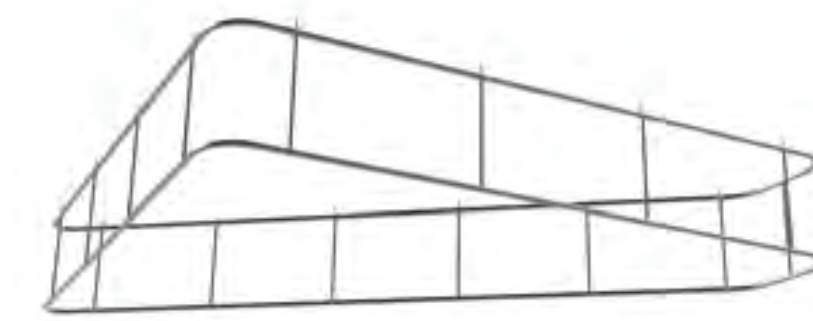

Lisävarusteena valaistus rakenteen sisälle





# Linear

Messuseinä pyöreä

 2280 (k) x 2500 (l) x 375 (s) mm





# Linear

Aksentit ovat tehty täydentämään rakenteita ja antamaan enemmän näkyvyyttä brändiviesteille.

Ac 05  2610 (k) x 1270 (l) x 2410(s) mm



Ac 20  2610 (k) x 870 (l) x 751 (s) mm

Ac 21  2610 (k) x 1070 (l) x 751 (s) mm



Ac 17  2516 (k) x 1700 (l) x 154,60 (s) mm



Ac 15  2808 (k) x 1270 (l) x 2610 (s) mm



Ac 14  2655 (k) x 1200 (l) x 232 (s) mm

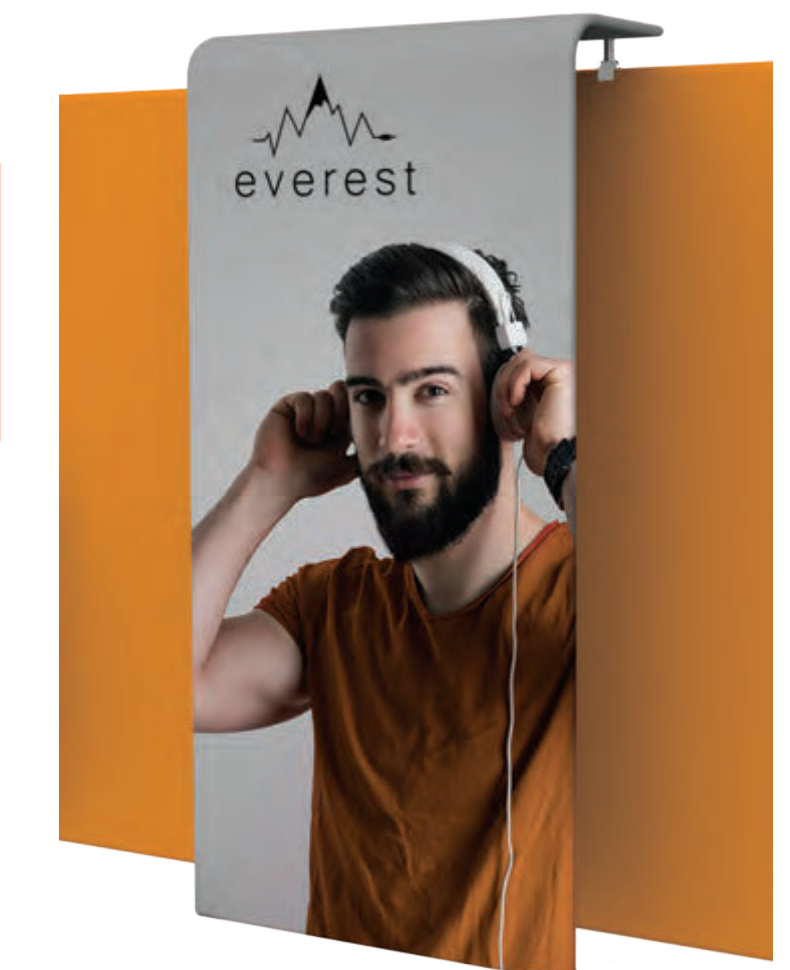

Ac 15A  2655 (k) x 450 (l) x 232 (s) mm

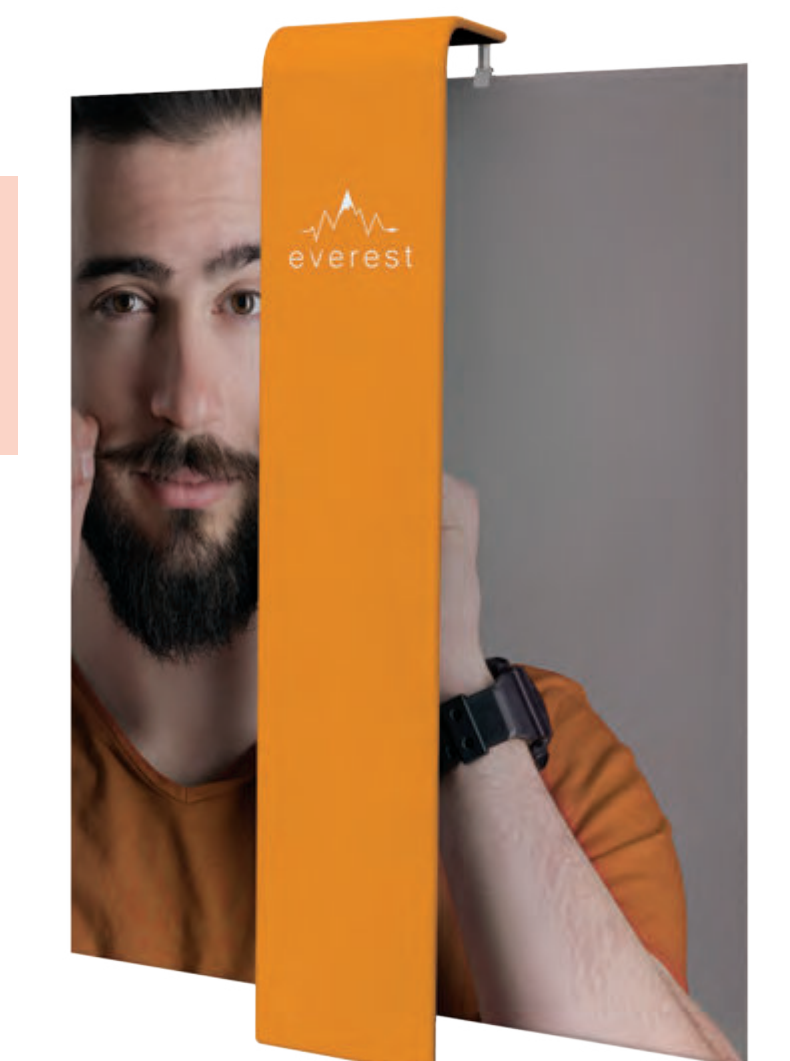





# Linear

Torneja on saatavilla eri korkeuksissa, nämä pylväät ovat ihanteellisia viestin korostamiseen. Käytä opastuspisteissä tai somistuksessa. Grafikka kangas koko pylvään ympäri.

**Lisävarusteena valaistus rakenteen sisälle**

Pylväs S  2500 (k) x 1000 (l) x 1000 (s) mm

Pylväs M  3000 (k) x 1000 (l) x 1000 (s) mm

Pylväs L  3500 (k) x 1000 (l) x 1000 (s) mm



# Linear

Voit yhdistellä useita pöytiä isommaksi kokonaisuudeksi. Runkoon sijoitetut magneetit yhdistävät osat toisiinsa ilman työkaluja tai lisäosia.

Korkeus 1015 mm Leveys 800 mm Syvyys 600 mm

**Grafiikkakangas pöytätason päällä tai alla.**

Grafiikka kangas koko pöydän ympäri. Pitkällä sivulla vetoketju, joka sulkee sisäänsä hyllyn ja tavarasi.



**Lisää pöytävaihtoehtoja löydät pöytäkuvastosta.**





# Linear

LED-valo pystyy edelleen tuottamaan 1200 lumenia, mutta kuluttaa silti vain pienen määrän energiaa. Suositus on sijoittaa yksi valaisin jokaista metriä kohden. Asennus kätevällä klipsillä.

**Värisävy 5631**

**1200 lumenia**

**4 x tehokkaampi kuin halogeeni**

**Jopa 22 000 tunnin käyttöikä**

Yhdistettävissä yhdestä muuntajasta, ne liitetään kätevästi liitoskaapaleilla. Max 5 valaisinta yhteen muuntajaan.



# Linear

Aksentti esimerkkejä





# Linear

Custom made





# Linear

3D Custom made

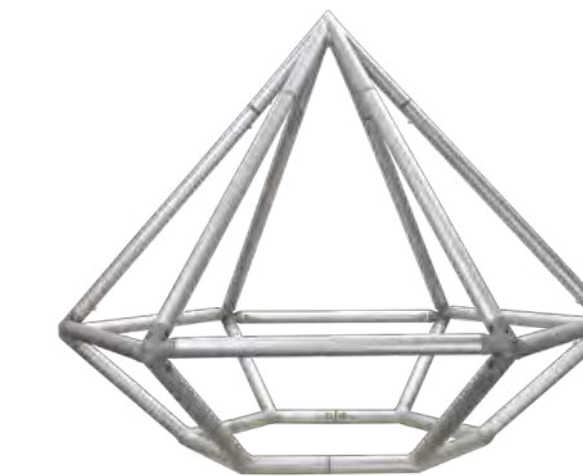
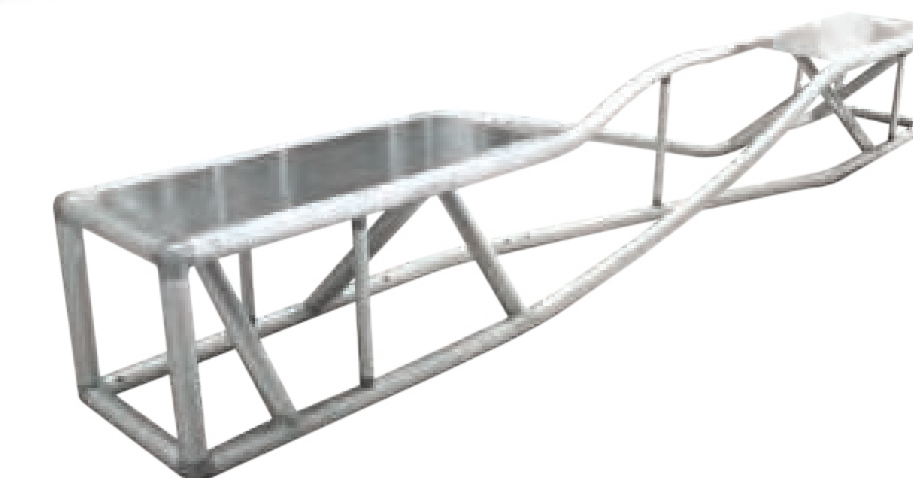
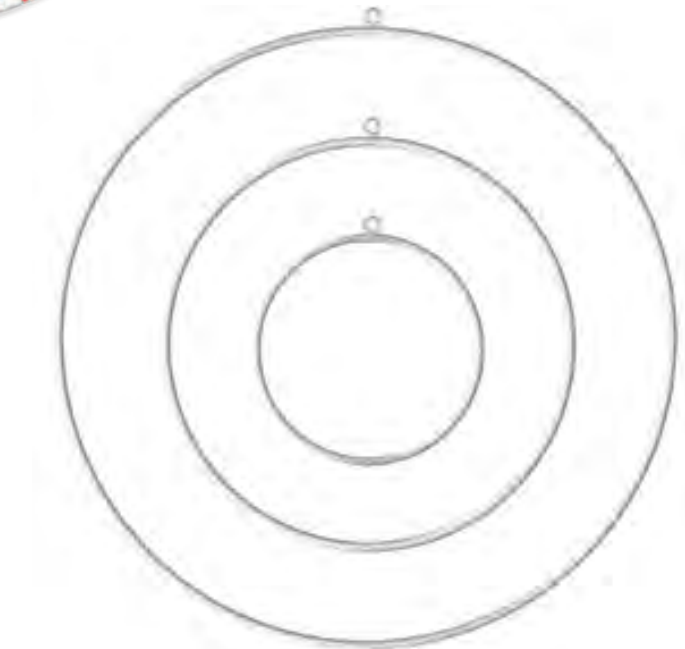



# Linear

## Esimerkkejä



# Linear

Lisävarusteita

Näyttöteline



Hylly



Esiteteline



Erilaiset ylimääräiset kantokassi





# Oma sisäinen verkkokauppa

Sisäisen verkkokaupan avulla yritys voi tilata ja hallinnoida messu ja tapahtuma tuotteita, brändi- ja Give Away -tuotteita sekä työvaatteita.



Sisäisellä verkkokaupalla on yleensä yrityksessä 1–2 pääkäyttäjää, jotka vastaavat tuotevalikoimasta yhdessä asiakasvastaavamme kanssa. Tuotevalikoimaa voidaan päivittää tarpeen mukaan, ja se elääkin

vahvasti esimerkiksi vuodenaikojen ja sesonkien mukana.

Teemme yrityksellesi ehdotuksen verkkokaupan ilmeestä sekä autamme tuotesuunnittelussa ja logon sijoittamisessa tuotteeseen. Kaikki verkkokauppa tuotteet ovat yrityksesi brändi-ilmeen mukaisia.

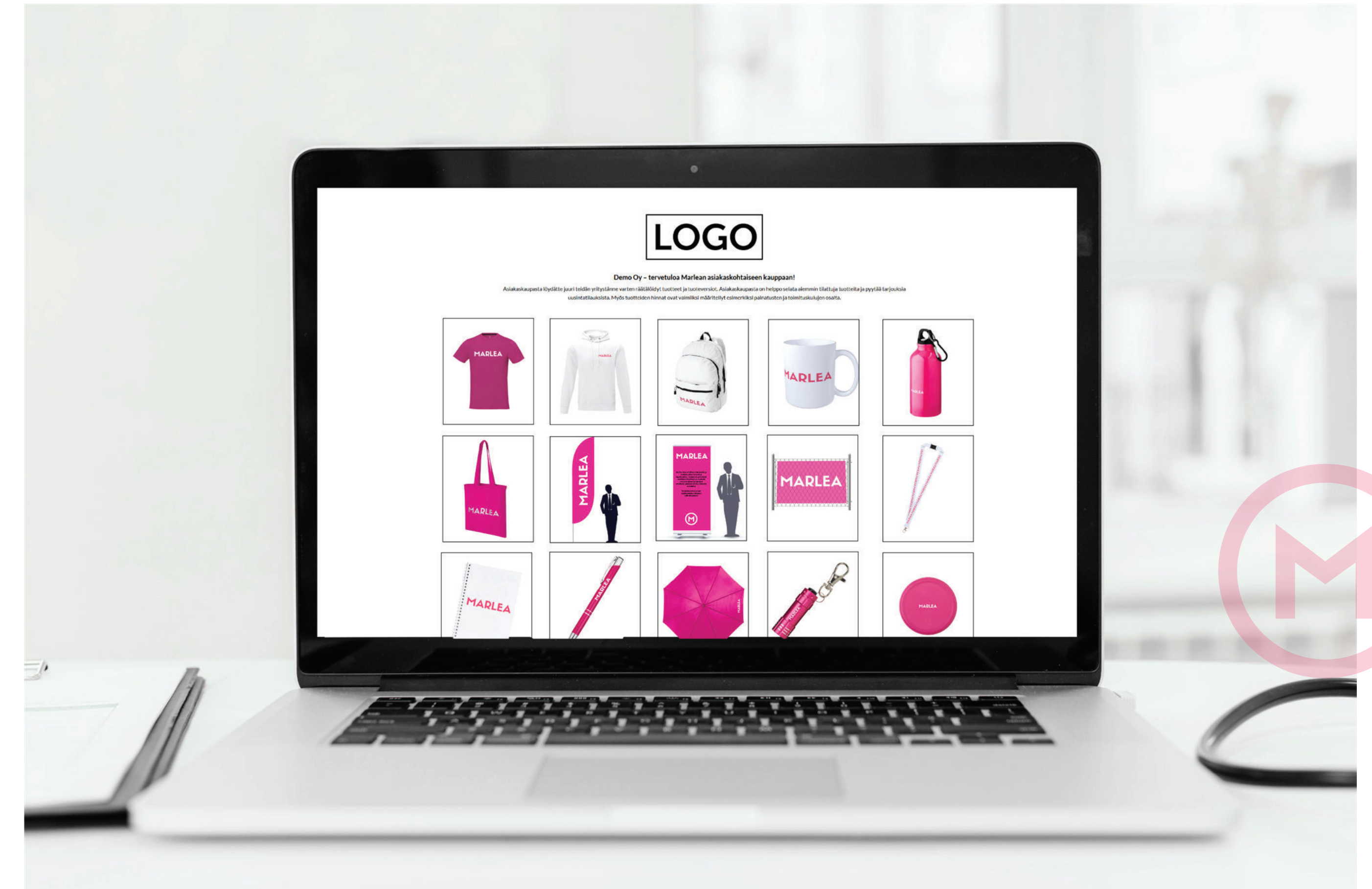
Verkkokauppa on asiakkaiden käytössä 1–2 viikon kuluessa starttipalaverista.



-  Kartoitamme tarpeen ja suunnittelemme juuri teille sopivan ratkaisun
-  Suunnitellette tuotevalikoiman yhdessä myyjämme kanssa brändiohjeistuksen mukaisesti
-  Yrityksen sisältä valitaan 1–2 pääkäyttäjää ja määritellään, ketkä yrityksessä ovat tilaajia



Ystävällisin terveisin

Marlean tiimi

**myynti@marlea.fi**

**+358 50 41382 77**



[www.marlea.fi](http://www.marlea.fi)

**MARLEA**